

1990±10

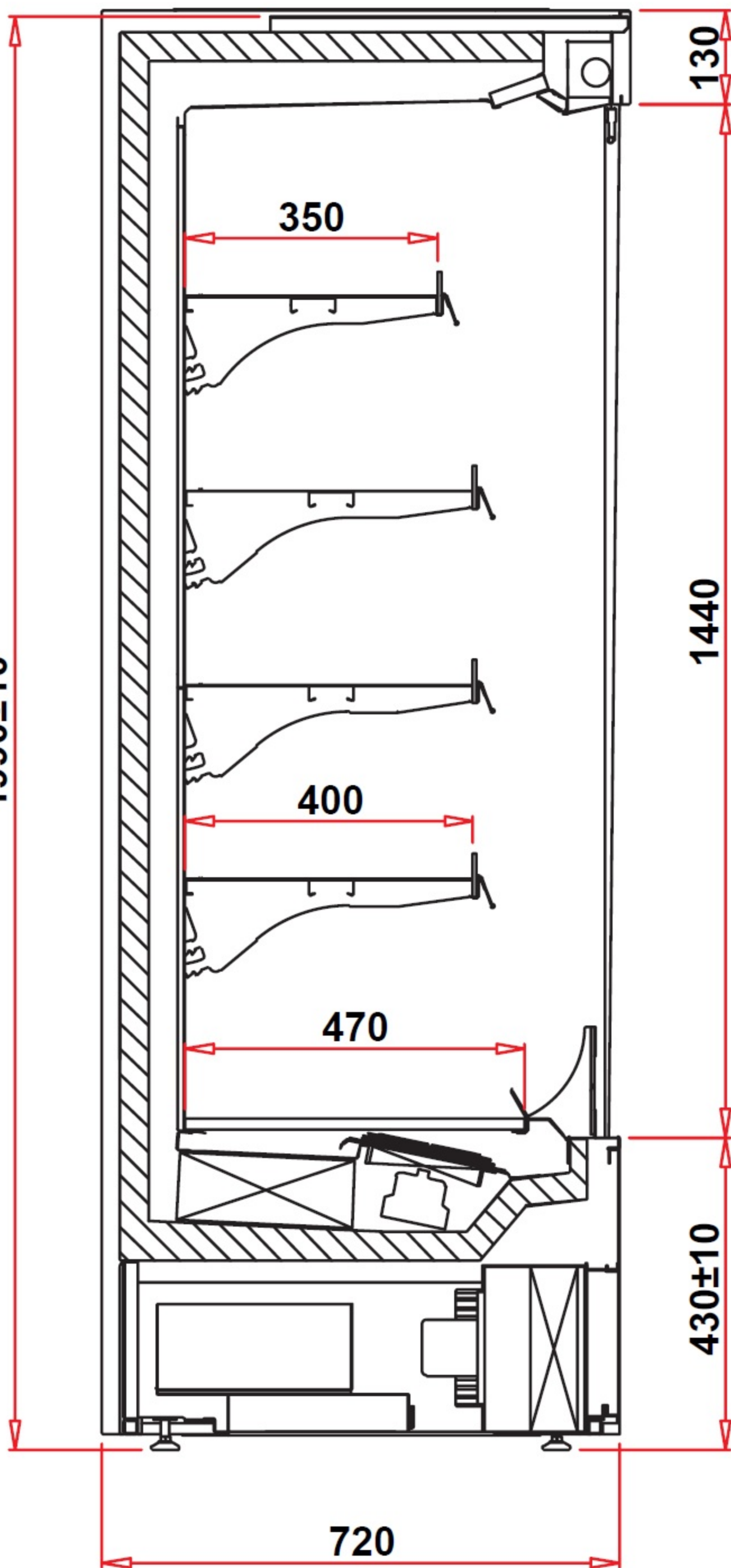

130

350

1440

400

470

430±10

720