

Saladette 950

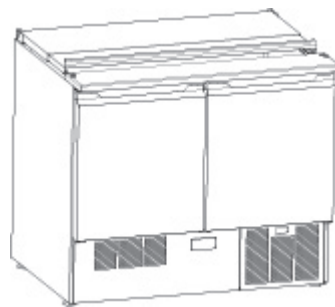

EN Installation and operating manual *



Installation diagram
 Saladette "950" with chopping-boarding

type SAL95AHC

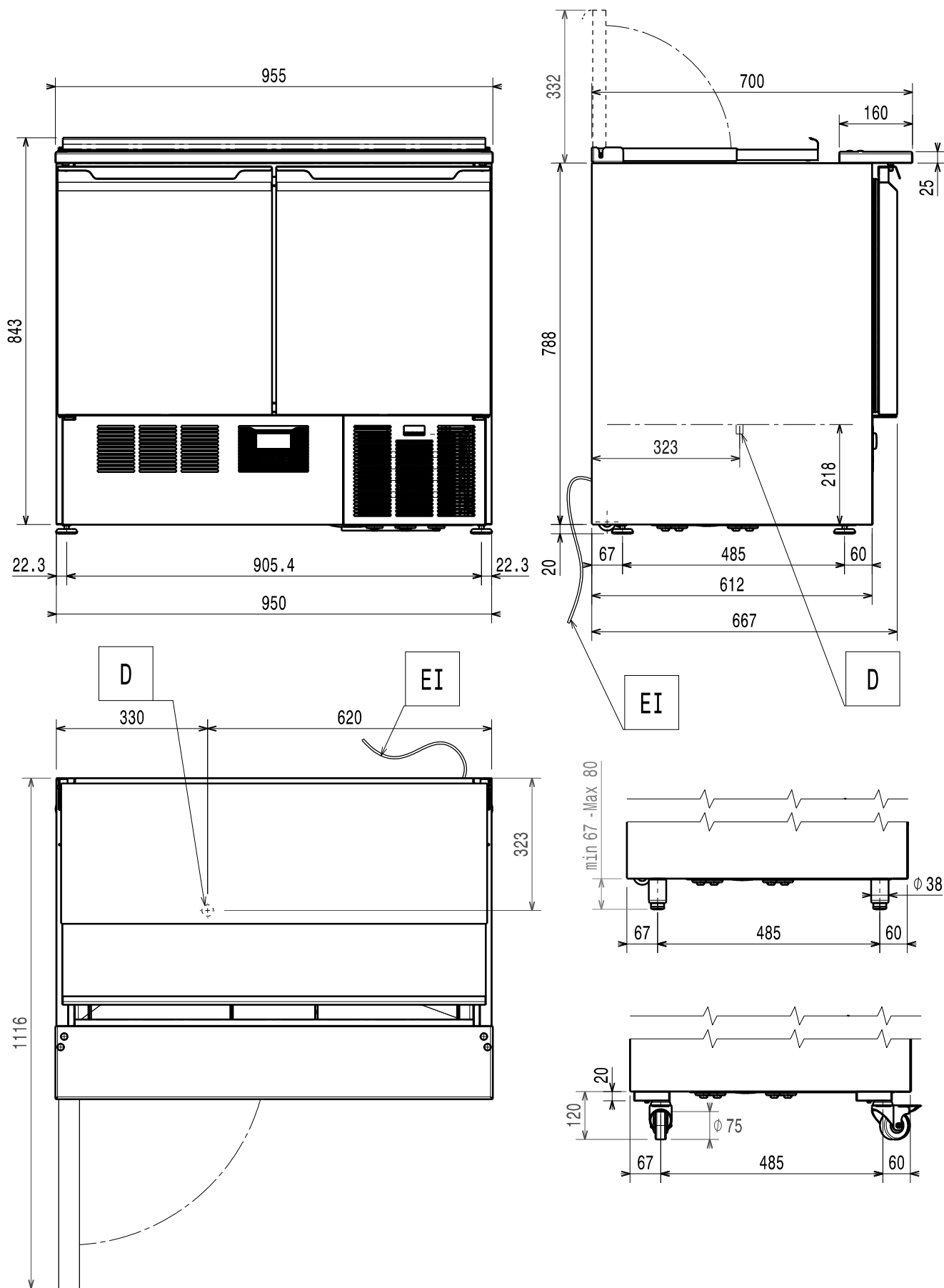

Installation diagram
Saladette "950" Pizza

type SAL95BHC

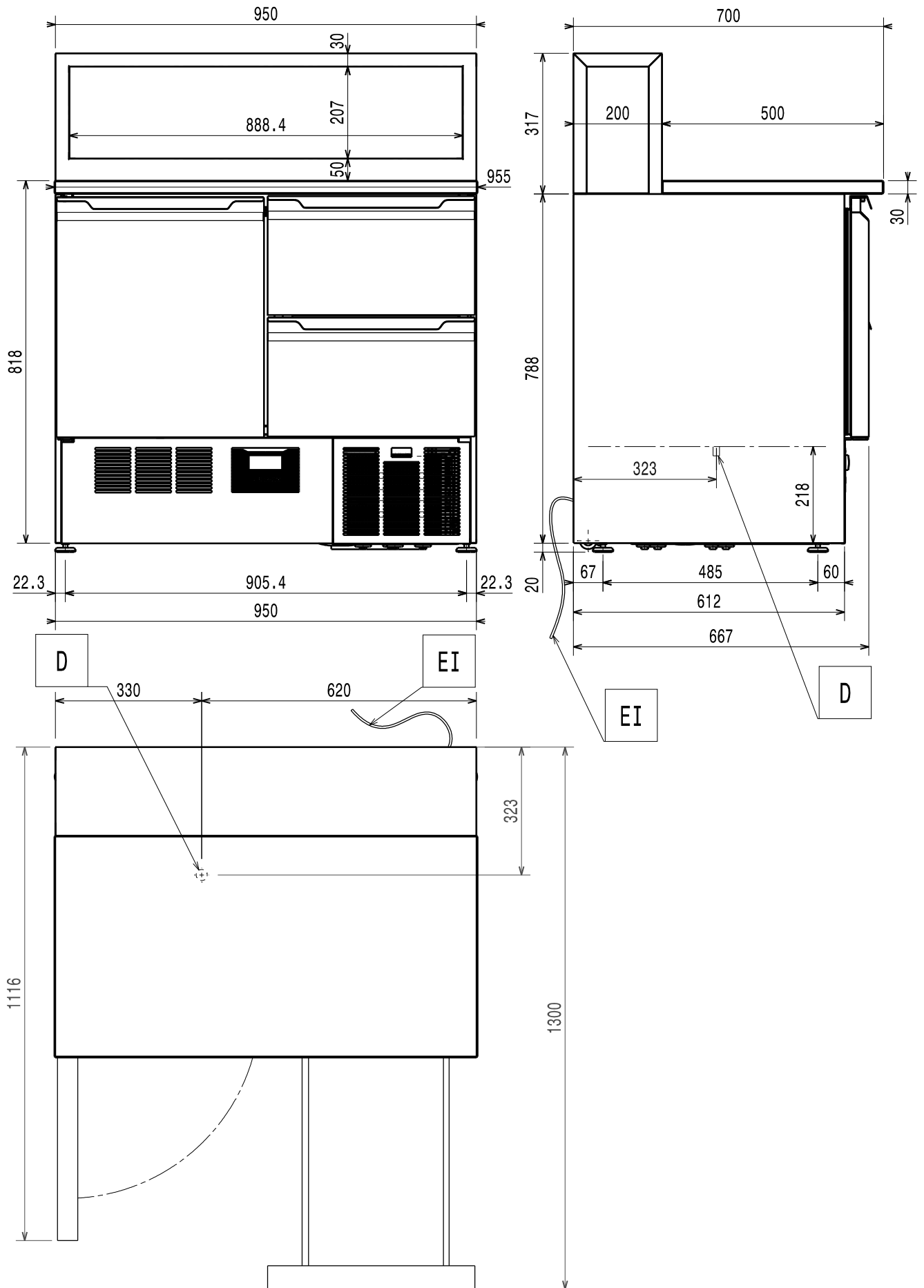

Installation diagram
Saladette "950" with steel top

type SAL95DHC

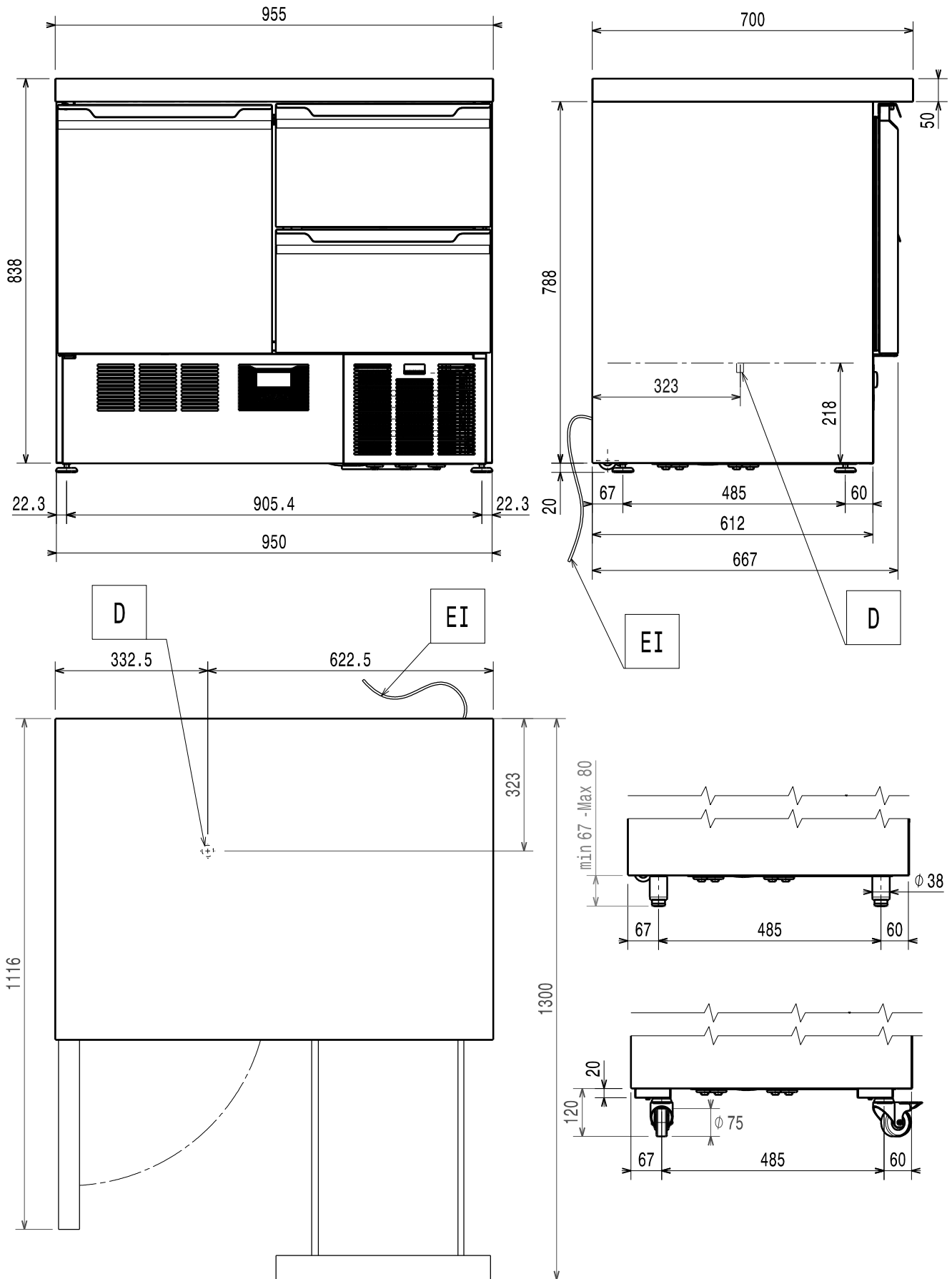

Installation diagram
Saladette "950" without top

type SAL95CHC

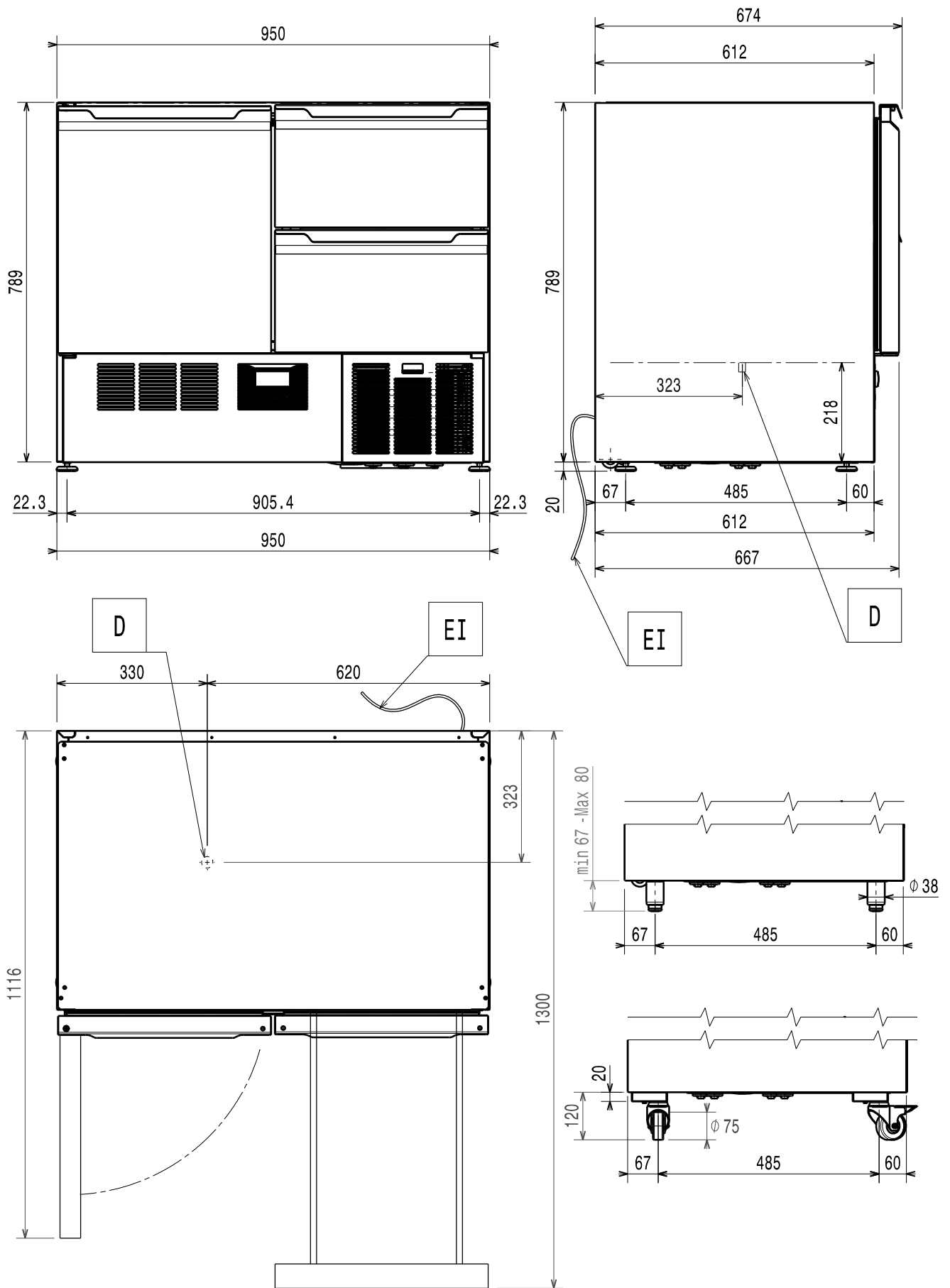

EI = Power cable length
TYPE = Certification group
SAL95 = Saladette 950 range
A = version with chopping-boarding

B = version Pizza
C = version with steel top
D = version without top
HC = R290 refrigerant

Foreword



Read the following instructions, including the warranty terms before installing and using the appliance.

Visit our website www.electroluxprofessional.com and open the **Support** section to:



Register your product



Get hints & tips of your product, service and repair information

The installation, use and maintenance manual (hereinafter Manual) provides the user with information necessary for correct and safe use of the appliance.

The following must not be considered a long and exacting list of warnings, but rather a set of instructions suitable for improving appliance performance in every respect and, above all, preventing injury to persons and animals and damage to property due to improper operating procedures.

All persons involved in appliance transport, installation, commissioning, use and maintenance, repair and disassembly must consult and carefully read this manual before carrying out the various operations, in order to avoid wrong and improper actions that could compromise the appliance's integrity or endanger people. Make sure to periodically inform the user regarding the safety regulations. It is also important to instruct and update personnel authorised to operate on the appliance, regarding its use and maintenance.

The manual must be available to operators and carefully kept in the place where the appliance is used, so that it is always at hand for consultation in case of doubts or whenever required.

If, after reading this manual, there are still doubts regarding appliance use, do not hesitate to contact the Manufacturer or the authorised Service Centre to receive prompt and precise assistance for better operation and maximum efficiency of the appliance. During all stages of appliance use, always respect the current regulations on safety, work hygiene and environmental protection. It is the user's responsibility to make sure the appliance is started and operated only in optimum conditions of safety for people, animals and property.



IMPORTANT

- The manufacturer declines any liability for operations carried out on the appliance without respecting the instructions given in this manual.
- The manufacturer reserves the right to modify the appliances presented in this publication without notice.
- No part of this manual may be reproduced.
- This manual is available in digital format by:
 - contacting the dealer or reference customer care;
 - downloading the latest and up to date manual on the web site;
- The manual must always be kept in an easily accessed place near the appliance. Appliance operators and maintenance personnel must be able to easily find and consult it at any time.

Contents

A	WARNING AND SAFETY INFORMATION	10
A.1	General information	10
A.2	Personal protection equipment	10
A.3	General safety	11
A.4	Protection devices installed on the appliance	11
A.5	Safety signs to be placed on the appliance or near its area	11
A.6	Reasonably foreseeable improper use	12
A.7	Residual risks	12
A.8	Technical data	13
A.9	Climatic Class	13
A.10	Transport, handling and storage	13
A.11	Installation and assembly	13
A.12	Electrical connection	13
A.13	Electrical connection for appliances with plug	13
A.14	Electrical connection for appliances with cable without plug	14
A.15	Positioning	14
A.16	Fitting anti-tipping cables	14
A.17	Appliance space limits	14
A.18	Product loading and unloading	14
A.19	Maximum load	14
A.20	Appliance cleaning	14
A.21	Cleaning the cabinet and accessories	14
A.22	Preventive Maintenance	15
A.23	Parts and accessories	15
A.24	Precautions for use and maintenance	15
A.25	Appliance maintenance	15
A.26	Maintenance intervals	15
A.27	Appliance disposal	16
B	WARRANTY TERMS AND EXCLUSIONS	16
C	APPLIANCE AND MANUFACTURER'S IDENTIFICATION DATA	16
D	GENERAL INFORMATION	17
D.1	Introduction	17
D.2	Intended use and restrictions	17
D.3	Testing and inspection	17
D.4	Copyright	17
D.5	Keeping the manual	17
D.6	Recipients of the manual	17
D.7	Definitions	17
D.8	Responsibility	17
E	TECHNICAL DATA	18
E.1	Materials and fluids used	18
E.2	Main technical characteristics	18
F	TRANSPORT, HANDLING AND STORAGE	18
F.1	Introduction	18
F.2	Handling	18
F.2.1	Procedures for handling operations	18
F.2.2	Placing the load	18
F.3	Unpacking	18
F.3.1	Disposal of packing	18
F.4	Storage	19
G	INSTALLATION AND ASSEMBLY	19
G.1	Introduction	19
G.2	Customer's responsibilities	19
G.3	Positioning	19
G.4	Fitting anti-tipping cables	19
H	CONTROL PANEL	20
H.1	Description of control panel	20
I	OPERATION	20
I.1	Switching on and temperature adjustment	20
I.2	Signalling icons	20
I.3	Alarms and signalling	21
I.3.1	Service alarms and signalling for models 0 °C/+10 °C	21
I.3.2	Temperature alarms and signalling	21
I.4	Defrost	21
I.5	Product loading	21
I.6	Tray loading combinations	21
J	NORMAL MACHINE USE	21
J.1	Characteristics of personnel trained for normal machine use	21
J.2	Characteristics of personnel enabled to operate on the machine	21
J.3	Operator qualified for normal machine use	21

K	MACHINE CLEANING AND MAINTENANCE.....	21
K.1	Ordinary maintenance	21
K.1.1	Care information	21
K.1.2	Cleaning the cabinet and accessories.....	22
K.1.3	Precautions in case of long idle periods	22
L	MACHINE DISPOSAL.....	22
L.1	Introduction	22
L.2	Waste storage.....	22
L.3	Procedure regarding appliance dismantling macro operations	22
M	TROUBLESHOOTING	23

A WARNING AND SAFETY INFORMATION

A.1 General information

To ensure safe use of the appliance and a proper understanding of the manual it is necessary to be familiar with the terms and typographical conventions used in the documentation. The following symbols are used in the manual to indicate and identify the various types of hazards:



WARNING

Danger for the health and safety of operators.



WARNING

Danger of electrocution - dangerous voltage.



CAUTION

Risk of damage to the appliance or the product.



WARNING

Risk of fire / Flammable materials



IMPORTANT

Important instructions or information on the product



Read the instructions before using the appliance



Clarifications and explanations

- Only specialised personnel are authorised to operate on the appliance.
- This appliance is not intended for use by persons (including children) with reduced physical, sensor or mental capabilities, or lack of experience and knowledge, unless they have been given supervision or instruction concerning use of appliance by a person responsible for their safety.
- Do not let children play with the appliance.
- Keep all packaging and detergents away from children.
- Cleaning and user maintenance shall not be made by children without supervision.
- Do not store explosive substances, such as pressurized containers with flammable propellant, in this appliance.
- Refer to the data given on the appliance's data plate for relations with the Manufacturer (e.g. when ordering spare parts, etc.).
- When scrapping the appliance, the marking must be destroyed.
- Save these instructions carefully for further consultation by the various operators.

A.2 Personal protection equipment

Summary table of the Personal Protection Equipment (PPE) to be used during the various stages of the appliance's service life.

Stage	Protective garments 	Safety footwear 	Gloves 	Glasses 	Safety helmet 
Transport	—	●	○	—	○
Handling	—	●	○	—	—
Unpacking	—	●	○	—	—
Installation	—	●	● ¹	—	—
Normal use	●	●	● ²	—	—
Adjustments	○	●	—	—	—
Routine cleaning	○	●	● ¹⁻³	○	—
Extraordinary cleaning	○	●	● ¹⁻³	○	—
Maintenance	○	●	○	—	—
Dismantling	○	●	○	○	—
Scrapping	○	●	○	○	—

Stage	Protective garments	Safety footwear	Gloves	Glasses	Safety helmet
					
Key:					
●	PPE REQUIRED				
○	PPE AVAILABLE OR TO BE USED IF NECESSARY				
—	PPE NOT REQUIRED				

- During these operations, gloves must be cut-resistant. Failure to use the personal protection equipment by operators, specialized personnel or users can involve exposure to damage to health (depending on the model).
- During these operations, gloves must protect hands from the cold tray when being removed from the appliance. Failure to use the personal protection equipment by operators, specialised personnel or users can involve exposure to chemical risk and cause possible damage to health (depending on the model).
- During these operations, gloves must be suitable for contact with chemical substances used (refer to the safety data sheet of the substances used for information regarding the required PPE). Failure to use the personal protection equipment by operators, specialized personnel or users can involve exposure to chemical risk and cause possible damage to health (depending on the model).

A.3 General safety

- The appliances are provided with electric and/or mechanical safety devices for protecting workers and the appliance itself.
- Never operate the appliance, removing, modifying or tampering with the guards, protection or safety devices.
- Do not make any modifications to the parts supplied with the appliance.
- Several illustrations in the manual show the appliance, or parts of it, without guards or with guards removed. This is purely for explanatory purposes. Do not use the appliance without the guards or with the protection devices deactivated.

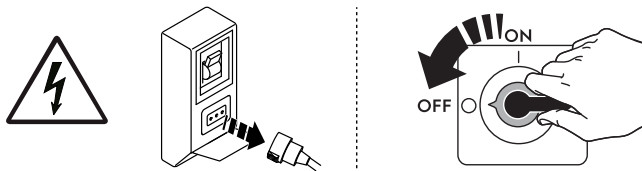

Disconnect the appliance from the power supply before carrying out any installation, assembly, cleaning or maintenance procedure.

- Do not remove, tamper with or make illegible the marking and safety, danger and instruction signs and labels on the appliance.
- The A-weighted emission sound pressure level does not exceed 70 dB(A).
- The following operations have to be carried out by specialised authorised personnel or Customer Care Service provided with all the appropriate personal protection equipment (A.2 *Personal protection equipment*), tools, utensils and ancillary means, who can ask the manufacturer to supply a servicing manual:
 - Installation and assembly
 - Installation of the refrigerant fluid condensing unit
 - Positioning
 - Electrical connection
 - Appliance cleaning, repair and extraordinary maintenance
 - Appliance disposal
 - Work on electrical equipment
 - Dismantling operations of appliances which use R290 or R-744 (with a refrigeration system under high pressure)
 - Dismantling operations of appliances which use flammable insulation blowing gase;



A.4 Protection devices installed on the appliance



Guards

The appliance has:

- fixed guards (e.g. casings, covers, side panels, etc.), fixed to the appliance and/or frame with screws or quick-release connectors that can only be removed or opened with tools; therefore the user must not remove or tamper with such devices. The Manufacturer declines any liability for damage due to tampering or their non-use;
- interlocked movable guards (door) for access inside the appliance;
- appliance electrical equipment access doors, made from hinged panels openable with tools. The door must not be opened when the appliance is connected to the power supply.

A.5 Safety signs to be placed on the appliance or near its area

Prohibition	Meaning
	do not remove the safety devices
	do not use water to extinguish fires (placed on electrical parts)

Danger	Meaning
	caution hot surface
	danger of electrocution (shown on electrical parts with indication of voltage)

A.6 Reasonably foreseeable improper use

Improper use is any use different from that specified in this manual. During appliance operation, other types of work or activities deemed improper and that in general can involve risks for the safety of operators and damage to the appliance are not allowed. Reasonably foreseeable improper use includes:

- lack of appliance maintenance, cleaning and periodical checks;
- structural changes or modifications to the operating logic;
- tampering with the guards or safety devices;
- failure to use personal protection equipment by operators, specialised personnel and maintenance personnel;
- failure to use suitable accessories (e.g. use of unsuitable equipment or ladders);
- keeping combustible or flammable materials, or in any case materials not compatible with or pertinent to the work, near the appliance;
- wrong appliance installation;
- placing in the appliance any objects or things not compatible with its use, or that can damage the appliance, cause injury or pollute the environment;
- climbing on the appliance;
- non-compliance with the requirements for correct appliance use;
- other actions that give rise to risks not eliminable by the Manufacturer.
- failure to insure complete closure of doors or drawers, through forgetfulness or carelessness
- place the product in the compartments so as to block proper air circulation or hinder the perfect closing of doors / drawers
- exceed product weight allowed for each shelf / drawer



WARNING

The previously described actions are prohibited!

A.7 Residual risks

The appliance has several risks that were not completely eliminated from a design standpoint or with the installation of adequate protection devices. Nevertheless, through this manual the Manufacturer has taken steps to inform operators of such risks, carefully indicating the personal protection equipment to be used by them. In order to reduce the risks, provide for sufficient spaces while installing the unit.

To preserve these conditions, the areas around the appliance must always be:

- kept free of obstacles (e.g. ladders, tools, containers, boxes, etc.);
- clean and dry;
- well lit.

For the Customer's complete information, the residual risks remaining on the appliance are indicated below: such actions are deemed improper and therefore strictly forbidden.

Residual risk	Description of hazardous situation
Slipping or falling	The operator can slip due to water, any liquid or dirt on the floor
Burns/abrasions (e.g. heating elements, cold pan, cooling circuit plates and pipes)	The operator deliberately or unintentionally touches some components inside the appliance without using protective gloves.
Electrocution	Contact with live parts during maintenance operations carried out with the electrical panel powered
Falling from above	The operator intervenes on the appliance using unsuitable systems to access the upper part (e.g. rung ladders, or climbs on it)
Crushing or injury	The specialised personnel may not correctly fix the control panel when accessing the technical compartment. The panel could close suddenly.
Tipping of loads	When handling the appliance or the packing containing it, using unsuitable lifting systems or accessories or with the unbalanced load
Chemical (refrigerant gas)	Inhalation of refrigerant gas. Therefore always refer to the appliance labels
Sudden closing of the door/drawers (if present, depending on the appliance type)	The operator for normal appliance use could suddenly and deliberately close (if present, depending on the appliance type): <ul style="list-style-type: none"> • door/s • drawers

A.8 Technical data

- The data plate and the energy labelling refer to original manufactured configuration.
- The appliance that can operate at 50 Hz or 60 Hz does not need any setting by the user.

Materials and fluids used

- R290 gas is potentially flammable and explosive. Take every possible precaution to prevent any risk linked to the nature of this gas during any routine and/or extraordinary operation carried out on the appliance.

A.9 Climatic Class

The climatic class given on the data plate refers to the following values:

- CLIMATIC CLASS: 5

Models with only doors

- 43°C (IEC/EN 60335-2-89)
- 40°C room with 40% relative humidity (EN 16825/EN ISO 22041).

Models with only drawers or mix (drawers and doors)

- 43°C (IEC/EN 60335-2-89)
- 30°C room with 55% relative humidity (EN 16825/EN ISO 22041).

A.10 Transport, handling and storage

- Transport (i.e. transfer of the appliance from one place to another) and handling (i.e. transfer inside workplaces) must occur with the use of special and adequate means.
- Please refer to indications on packaging for stackability during transport, handling and storage.
- Do not stand under suspended loads during loading or unloading operations. Unauthorized personnel must not enter the work area.
- The weight of the appliance alone is not sufficient to keep it steady.
- For appliance lifting and anchoring, do not use movable or weak parts such as: casings, electrical raceways, pneumatic parts, etc.
- Do not push or pull the appliance to move it, as it may tip over. Use proper tool to lift the appliance.
- Arrange a suitable area with flat floor for appliance unloading and storage operations.
- Appliance transport, handling and storage personnel must be adequately instructed and trained regarding the safely use of lifting systems and personal protection equipment suitable for the type of operation carried out.
- When removing the anchoring systems, make sure the stability of the appliance parts does not depend on the anchoring and, therefore, that this operation does not cause the load to fall off the vehicle. Before unloading the appliance components, make sure all the anchoring systems are removed.

A.11 Installation and assembly

- The installer must evaluate the minimum volume of the installation's environment necessary to reduce the risks related to danger caused by the flammability and toxicity of the refrigerant present in the appliance.
- The operations described must be carried out in compliance with the current safety regulations and provisions in force in the country of use.
- The machine is not suitable for installation outdoors and/or in places exposed to atmospheric agents (rain, direct sunlight, etc.).

A.12 Electrical connection

- The power supply system must be suitable for the rated current of the connected appliance; the connection must be carried out in compliance with the regulations and provisions in force in the country of use.
- The information regarding the appliance power supply voltage is given on the dataplate.
- Install between the power cable and the electric line a differential thermal-magnetic switch suitable for the absorption specified on the data plate, with contact gap enabling complete disconnection in category III overvoltage conditions and complying with the regulations in force.
For the correct sizing of the switch or plug, refer to the absorbed current specified on the appliance data plate.
- After making the connection, with the appliance running check that the power supply does not fluctuate by $\pm 10\%$ the rated voltage.
- If the power cable is damaged, it must be replaced by the Customer Care Service or in any case by specialised personnel, in order prevent any risk.
- The manufacturer declines any liability for damage or injury resulting from breach of the above rules or non-compliance with the electrical safety regulations in force in the country where the appliance is used.

A.13 Electrical connection for appliances with plug

- To connect to the power supply, insert the power cable plug in the corresponding mains socket, first making sure:
 - the socket has an efficient earth contact and the mains voltage and frequency match that given on the dataplate. In case of any doubts regarding the efficiency of the earth connection have the system checked by specialised personnel.
 - the system power supply is arranged and able to take the actual current absorption and that it is correctly executed according to the regulations in force in the country of use.
- The plug must be accessible after positioning the appliance in the place of installation.
- The plug must be in a position always visible to the operator performing the intervention during maintenance operations.

A.14 Electrical connection for appliances with cable without plug

- The connection point has an efficient earth contact and the mains voltage and frequency match that given on the data plate. In case of doubts regarding the efficiency of the earth wire, have the system checked by specialised personnel.
- The appliance must be permanently connected to the power supply, respecting the polarities:
 - brown/black¹/gray¹: phase
 - yellow/green: earth
 - blue: neutral
- An H05VV-F type power cable (code 60227 IEC 53) is used for the permanent connection to the mains; in case of replacement, use a type with at least these characteristics. When replacing the cable, the earth wire must be kept longer than the live and neutral wires.
- The differential thermal-magnetic switch must be lockable in the open position in case of maintenance.
- If using a plug, it must comply with the national installation rules. The plug must also be:
 - accessible after the appliance has been positioned
 - in the place of installation;
 - in a position always visible to the operator performing the intervention during maintenance operations;

A.15 Positioning

- Install the appliances, taking all the safety precautions required for this type of operation, also respecting the relevant fire-prevention measures.

A.16 Fitting anti-tipping cables

- All models with 4 drawers MUST be fixed to the wall by means of the appropriate anti-tipping cables accessory:
- To fit proceed as shown in the paragraph G.4 *Fitting anti-tipping cables*.

A.17 Appliance space limits

- Make sure to position the appliance at least 50 mm from any other appliances present in the room (in fact, close proximity can create problems of condensate forming on the walls of the appliance), also taking into consideration the space needed for door opening.

A.18 Product loading and unloading

- Cover or wrap food before placing it in the appliance.
- Do not use spray products for defrosting; in fact, they can be harmful to the health and/or damage the materials the appliance is made from.

WARNING:

- Do not use mechanical devices or other means to speed up the defrost process, unless recommended by the manufacturer.
- Do not damage the refrigerant circuit.
- Do not use electrical appliances inside the appliance compartments for storing frozen food, unless such equipment is recommended by the manufacturer.
- Keep the ventilation openings in the appliance casing free of any obstructions.

A.19 Maximum load

Regarding the maximum load for each shelf, respect that given in the table below:

SHELF MAXIMUM LOAD	20 KG
--------------------	-------

A.20 Appliance cleaning

- Do not touch the appliance with wet hands or feet or when barefoot.
- Use a ladder with suitable protection for work on appliances with high accessibility.
- Put the appliance in safe conditions before starting any cleaning operation.
- Respect the requirements for the various routine and extraordinary maintenance operations. Non-compliance with the instructions can create risks for personnel.
- Do not spray water or use water jets, steam cleaner or high pressure cleaner.

A.21 Cleaning the cabinet and accessories

- Pay attention to the selection and use of cleaning products in order to maintain proper appliance performance and safeness.
- Before using the appliance, clean all the internal parts and accessories with lukewarm water and neutral soap, or products that are over 90% biodegradable (in order to reduce the emission of pollutants into the environment), then rinse and dry thoroughly, where possible clean with dishwashing machine.
- Do not clean the appliance with detergents containing chlorine, solvent-based cleaning products (e. g. trichloro-ethylene), abrasive powders or agents, scouring pads or sponges that could damage the surfaces. Do not use organic solvent substances or essential oils. These substances could damage the parts of the appliance made from synthetic material.
- Do not use products (even if diluted) containing chlorine (sodium hypochlorite, hydrochloric or muriatic acid, etc.) to clean the floor under the appliance.
- It is advisable to stipulate a preventive and scheduled maintenance contract with the Customer Care Service.

1. present only in appliances with three-phase power supply

A.22 Preventive Maintenance

In order to ensure the safety and performance of your equipment, it is recommended that service is undertaken by Electrolux Professional authorised engineers every 12 months, in accordance with Electrolux Professional Service Manuals. Please contact your local Electrolux Professional Service Centre for further details.

A.23 Parts and accessories

Use only original accessories and/or spare parts. Failure to use original accessories and/or spare parts will invalidate the original manufacturer warranty and may render the appliance not compliant with the safety standard.

A.24 Precautions for use and maintenance

- Risks mainly of a mechanical, thermal and electrical nature exist in the machine. Where possible the risks have been neutralised:
 - directly, by means of adequate design solutions.
 - indirectly by using guards, protection and safety devices.
- Any anomalous situations are signalled on the control panel display.
- During maintenance several risks remain, as these could not be eliminated, and must be neutralised by adopting specific measures and precautions.
- Do not carry out any checking, cleaning, repair or maintenance operations on moving parts. Workers must be informed of this prohibition by means of clearly visible signs.
- To guarantee machine efficiency and correct operation, periodical maintenance must be carried out according to the instructions given in this manual.
- Make sure to periodically check correct operation of all the safety devices and the insulation of electrical cables, which must be replaced if damaged.

A.25 Appliance maintenance

- The inspection and maintenance intervals depend on the actual appliance operating conditions and ambient conditions (presence of dust, damp, etc.), therefore precise time intervals cannot be given. In any case, careful and periodical appliance maintenance is advisable in order to minimise service interruptions.
- It is advisable to stipulate a preventive and scheduled maintenance contract with the Customer Care Service.
- Put the appliance in safe conditions before starting any maintenance operation.

A.26 Maintenance intervals

It is advisable to carry out the checks with the frequency given in the following table:

Maintenance, inspections, checks and cleaning	Frequency	Responsibility
Ordinary cleaning <ul style="list-style-type: none">• general cleaning of appliance and surrounding area	<ul style="list-style-type: none">• Daily	<ul style="list-style-type: none">• Operator
Mechanical protection devices <ul style="list-style-type: none">• check their condition and for any deformation, loosening or removed parts	<ul style="list-style-type: none">• Yearly	<ul style="list-style-type: none">• Service
Control <ul style="list-style-type: none">• check the mechanical part, for cracks or deformation, tightening of screws: check the readability and condition of words, stickers and symbols and restore if necessary	<ul style="list-style-type: none">• Yearly	<ul style="list-style-type: none">• Service
Appliance structure <ul style="list-style-type: none">• tightening of main bolts (screws, fixing systems, etc.) of appliance	<ul style="list-style-type: none">• Yearly	<ul style="list-style-type: none">• Service
Safety signs <ul style="list-style-type: none">• check the readability and condition of safety signs	<ul style="list-style-type: none">• Yearly	<ul style="list-style-type: none">• Service
Electrical control panel <ul style="list-style-type: none">• check the electrical components installed inside the electrical control panel. Check the wiring between the electrical panel and appliance parts.	<ul style="list-style-type: none">• Yearly	<ul style="list-style-type: none">• Service

Maintenance, inspections, checks and cleaning	Frequency	Responsability
Electrical connection cable <ul style="list-style-type: none"> check the connection cable (replace if necessary) 	<ul style="list-style-type: none"> Yearly 	<ul style="list-style-type: none"> Service
General appliance overhaul <ul style="list-style-type: none"> check all components, electrical equipment, corrosion, pipes... 	<ul style="list-style-type: none"> Every 10 years ² 	<ul style="list-style-type: none"> Service

A.27 Appliance disposal

- Make the appliance unusable by removing the power cable and any compartment closing devices, to prevent the possibility of someone becoming trapped inside.

B WARRANTY TERMS AND EXCLUSIONS

If the purchase of this product includes warranty coverage, warranty is provided in line with local regulations and subject to the product being installed and used for the purposes as designed, and as described within the appropriate equipment documentation.

Warranty will be applicable where the customer has used only genuine spare parts and has performed maintenance in accordance with Electrolux Professional user and maintenance documentation made available in paper or electronic format.

Electrolux Professional strongly recommends using Electrolux Professional approved cleaning, rinse and descaling agents to obtain optimal results and maintain product efficiency over time.

The Electrolux Professional warranty does not cover:

- service trips cost to deliver and pick up the product;
- installation;
- training on how to use/operate;
- replacement (and/or supply) of wear and tear parts unless resulting from defects in materials or workmanship reported within one (1) week from the failure;
- correction of external wiring;
- correction of unauthorized repairs as well as any damages, failures and inefficiencies caused by and/or resulting from:
 - insufficient and/or abnormal capacity of the electrical systems (current/voltage/frequency, including spikes and/or outages);
 - inadequate or interrupted water supply, steam, air, gas (including impurities and/or other that does not comply with the technical requirements for each appliance);
 - plumbing parts, components or consumable cleaning products that are not approved by the manufacturer;

– customer's negligence, misuse, abuse and/or non-compliance with the use and care instructions detailed within the appropriate equipment documentation;

– improper or poor: installation, repair, maintenance (including tampering, modifications and repairs carried out by third parties not authorized) and modification of safety systems;

– Use of non-original components (e. g.: consumables, wear and tear, or spare parts);

– environment conditions provoking thermal (e. g. overheating/freezing) or chemical (e. g. corrosion/oxidation) stress;

– foreign objects placed in- or connected to- the product;

– accidents or force majeure;

– transportation and handling, including scratches, dents, chips, and/or other damage to the finish of the product, unless such damage results from defects in materials or workmanship and is reported within one (1) week of delivery unless otherwise agreed;

- product with original serial numbers that have been removed, altered or cannot be readily determined;
- replacement of light bulbs, filters or any consumable parts;
- any accessories and software not approved or specified by Electrolux Professional.

Warranty does not include scheduled maintenance activities (including the parts required for it) or the supply of cleaning agents unless specifically covered within any local agreement, subject to local terms and conditions.

Check on Electrolux Professional website the list of authorized customer care.

C APPLIANCE AND MANUFACTURER'S IDENTIFICATION DATA

The data plate gives the product identification and technical data.

An example of the marking or data plate on the appliance is given below:



F.Mod. XXXXXXXXX	Comm.Model XXXXXXXXX	Type ref. XXXXXX	2019
PNC 9V7X XXXXXXXXX	Ser.No. XXXXXXXXX	Cyclopentane	
W Tot. xxx kW	Volt XXXX - XXX XXHz	Total Current xx A	
Potenza Sbrinamento / Defrost Power	xxx kW	Classe / Class X	GWP XXXX CO2-eq XXX t
Resistenza Evaporazione / Evaporation Heater El.	X kW	Refrigerante / Refrigerant XXXXX	XX Kg
Illuminazione / Lighting	X W	Cap. X	
IPxx		CE	WEEE
Electrolux Professional SPA - Viale Treviso, 15 - 33170 Pordenone (Italy)			

The meaning of the various information given on it is listed below:

F.Mod.	factory description of product
Comm.Mod.	commercial description
PNC	production number code
Ser.No.	serial number
Type ref.	certification group of the appliance
Cyclopentane	expanding gas used in insulation
V	power supply voltage
Hz	power supply frequency
kW	power input
A	absorbed current
Evaporation heater El.	evaporation heating element power
Class	climatic class
GWP	global warming potential

- the machine is designed and built for a duration of about 10 years. After this period of time (from commissioning) the machine must undergo a general inspection and overhaul.

CO2 eq	quantity of greenhouse gases
Lighting	internal light
Cap.	nominal capacity
Refrigerant	type of refrigerant gas
Defrost power	current absorbed

	CE marking
	WEEE symbol
IPX3	dust and water protection rating

D GENERAL INFORMATION



WARNING

Refer to “*Warning and Safety Information*”.

D.1 Introduction

The drawings and diagrams given in the manual are not in scale. They supplement the written information with an outline, but are not intended to be a detailed representation of the machine supplied.

The numerical values given on the appliance installation diagrams refer to measurements in millimeters and/or inches.

D.2 Intended use and restrictions

Our appliances are designed and optimised in order to obtain high performance and efficiency. This appliance is designed for the refrigeration and preservation of foods.

Any other use is deemed improper.



CAUTION

The machine is not suitable for installation outdoors and/or in places exposed to atmospheric agents (rain, direct sunlight, etc.).



NOTE!

The manufacturer declines any liability for improper use of the product.

D.3 Testing and inspection

Our appliances have been designed and optimized, with laboratory testing, in order to obtain high performance and efficiency.

The appliance is shipped ready for use.

Passing of the tests (visual inspection - electrical test - functional test) is guaranteed and certified by the specific enclosures.

D.4 Copyright

This manual is intended solely for consultation by the operator and can only be given to third parties with the permission of Electrolux Professional company.

D.5 Keeping the manual

The manual must be carefully kept for the entire life of the machine, until scrapping. The manual must stay with the machine in case of transfer, sale, hire, granting of use or leasing.

D.6 Recipients of the manual

This manual is intended for:

- the carrier and handling personnel;
- installation and commissioning personnel;
- the employer of machine users and the workplace manager;
- operators for normal machine use;
- specialised personnel - Customer Care service (see service manual).

D.7 Definitions

Listed below are the definitions of the main terms used in the manual. It is advisable to read them carefully before use.

Operator	appliance installation, adjustment, use, maintenance, cleaning, repair and transport personnel.
Manufacturer	Electrolux Professional SpA or any other service centre authorised by Electrolux Professional SpA.
Operator for normal appliance use	an operator who has been informed and trained regarding the tasks and hazards involved in normal appliance use.
Customer Care service or specialised personnel	an operator instructed/trained by the Manufacturer and who, based on his professional and specific training, experience and knowledge of the accident-prevention regulations, is able to appraise the operations to be carried out on the appliance and recognise and prevent any risks. His professionalism covers the mechanical, electrotechnical and electronics fields etc.
Danger	source of possible injury or harm to health.
Hazardous situation	any situation where an operator is exposed to one or more hazards.
Risk	a combination of probabilities and risks of injury or harm to health in a hazardous situation.
Protection devices	safety measures consisting of the use of specific technical means (guards and safety devices) for protecting operators against risks.
Guard	an element of a machine used in a specific way to provide protection by means of a physical barrier.
Safety device	a device (other than a guard) that eliminates or reduces the risk; it can be used alone or in combination with a guard.
Customer	the person who purchased the appliance and/or who manages and uses it (e.g. company, entrepreneur, firm).
Electrocution	an accidental discharge of electric current on a human body.

D.8 Responsibility

The Manufacturer declines any liability for damage and malfunctioning caused by:

- non-compliance with the instructions contained in this manual;
- repairs not carried out in a workmanlike fashion, and replacements with parts different from those specified in the spare parts catalogue (the fitting and use of non-original spare parts and accessories can negatively affect machine operation and invalidates the original manufacturer warranty);
- operations carried out by non-specialised personnel;
- unauthorized modifications or operations;
- missing, lack or inadequate maintenance;
- improper machine use;
- unforeseeable extraordinary events;
- use of the machine by uninformed and / or untrained personnel;

- non-application of the current provisions in the country of use, concerning safety, hygiene and health in the workplace.

The Manufacturer declines any liability for damage caused by arbitrary modifications and conversions carried out by the user or the Customer.

The employer, workplace manager or service technician are responsible for identifying and choosing adequate and suitable

personal protection equipment to be worn by operators, in compliance with regulations in force in the country of use.

The Manufacturer declines any liability for inaccuracies contained in the manual, if due to printing or translation errors.

Any supplements to the installation, use and maintenance manual the Customer receives from the Manufacturer will form an integral part of the manual and therefore must be kept together with it.

E TECHNICAL DATA



WARNING

Refer to “*Warning and Safety Information*”.

E.1 Materials and fluids used

The areas in contact with the product are in steel or coated with non-toxic plastic material.

The fluorinated gases are contained in a hermetically sealed device.

HC refrigerant fluid R290, complying with the current regulations, is used in the refrigerating units. The type and quantity of gas used are given on the dataplate.

The CO2 equivalent of the gas may be calculated multiplying GWP value by quantity of gas.

E.2 Main technical characteristics

Power supply voltage V	220–240V 50 Hz or 60 Hz
Temperature range in compartment	0°C/+ 10°C

F TRANSPORT, HANDLING AND STORAGE



WARNING

Refer to “*Warning and Safety Information*”.

F.1 Introduction

Transport (i. e. transfer of the machine from one place to another) and handling (i. e. transfer inside workplaces) must occur with the use of special and adequate means.



CAUTION

The machine must only be transported, handled and stored by specialised personnel, who must have:

- specific technical training and experience in the use of lifting systems;
- knowledge of the safety regulations and applicable laws in the relevant sectors;
- knowledge of the general safety rules;
- personal protection equipment suitable for the type of operation carried out;
- the ability to recognize and avoid any possible hazard.

F.2 Handling



CAUTION

The appliances must be handled in the upright position. If the appliance is handled in a horizontal position, make sure to wait a few hours before making it operational.

F.2.1 Procedures for handling operations

Before lifting:

- send all operators to a safe position and prevent persons from entering the handling area;
- make sure the load is stable;
- make sure no material can fall during lifting. Manoeuvre vertically in order to avoid impacts;
- handle the machine, keeping it at minimum height from the ground.

F.2.2 Placing the load

Remove the appliance from the wooden pallet, move it to one side, then slide it onto the floor.

F.3 Unpacking



IMPORTANT

Immediately check for any damage caused during transport. Inspect the packaging before and after unloading.

Remove the packaging. Take care when unpacking and handling of the appliance to not cause any shocks on itself.



NOTE!

- The forwarder is responsible for the goods during transport and delivery.
- Make a complaint to the forwarder in case of visible or hidden damage.
- Specify any damage or shortages on the dispatch note.
- The driver must sign the dispatch note: the forwarder can reject the claim if the dispatch note is not signed (the forwarder can provide the necessary form).



Unpack the machine carrying out the following operations:

- cut the straps and remove the protective film, taking care not to scratch the surface if scissors or blades are used;
- remove the cardboard top, the polystyrene corners and the vertical protection pieces;
- for appliances with stainless steel cabinet, remove the protective film very slowly without tearing it, to avoid leaving glue stuck to the surface;
- should this happen, remove the traces of glue with a non-corrosive solvent, rinsing it off and drying thoroughly;
- it is advisable to go over all the stainless steel surfaces with a rag soaked in paraffin oil in order to create a protective film.

F.3.1 Disposal of packing

The packing must be disposed of in compliance with the current regulations in the country where the appliance is used. All the packing materials are environmentally friendly.

They can be safely kept, recycled, or burned in an appropriate waste incineration plant. Recyclable plastic parts are marked as follows:

 PE	Polyethylene <ul style="list-style-type: none"> • Outer wrapping • Instructions bag
 PP	Polypropylene <ul style="list-style-type: none"> • Straps
 PS	Polystyrene foam <ul style="list-style-type: none"> • Corner protectors

The parts in wood and cardboard can be disposed of, respecting the current regulations in the country where the machine is used.

F.4 Storage

The machine and/or its parts must be stored and protected from damp, in a non-aggressive place, free of vibrations and with room temperatures between 5°C and 50°C.

The place where the machine is stored must have a flat support surface to avoid deforming the machine or damage to the support feet.



CAUTION

Do not make modifications to the parts supplied with the appliance. Any missing or faulty parts must be replaced with original parts.

The appliance must be levelled, otherwise its operation could be affected.

G INSTALLATION AND ASSEMBLY



WARNING

Refer to “*Warning and Safety Information*”

G.1 Introduction

To ensure correct operation of the appliance and maintain safe conditions during use, carefully follow the instructions given below in this section.



CAUTION

Before moving the appliance make sure the load bearing capacity of the lifting equipment used is suitable for its weight.

G.2 Customer's responsibilities

The tasks and works required of the Customer are:

- arrange an earthed power socket of suitable capacity for the input specified on the data plate;
- provide a high sensitivity manual-reset differential thermal magnetic switch;
- for information regarding the electrical connection, refer to “A.12 *Electrical connection*”;
- check the floor planarity on which the appliance is placed.

G.3 Positioning

Install the appliance in a ventilated place, away from heat sources such as radiators or air conditioning systems, to allow correct cooling of the refrigerating unit components.

To avoid compromising proper appliance operation, never (even temporarily) cover the condenser or the front panel slits.

The machine must be taken to the place of installation and removed from the packing base only when being installed.

If the machine is installed in a place where there are corrosive substances (chlorine, etc.), it is advisable to go over all the stainless steel surfaces with a rag soaked in paraffin oil to create a protective film.

Arranging the machine:

- position the machine in the required place;
- make sure the appliance is level, also checking door and drawer closing;

The appliance must be levelled, otherwise its operation could be affected.

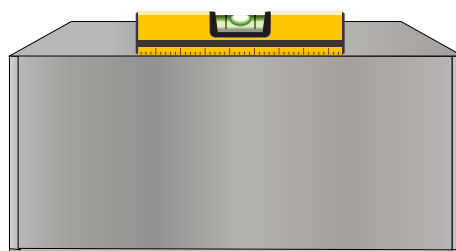

G.4 Fitting anti-tipping cables

1.

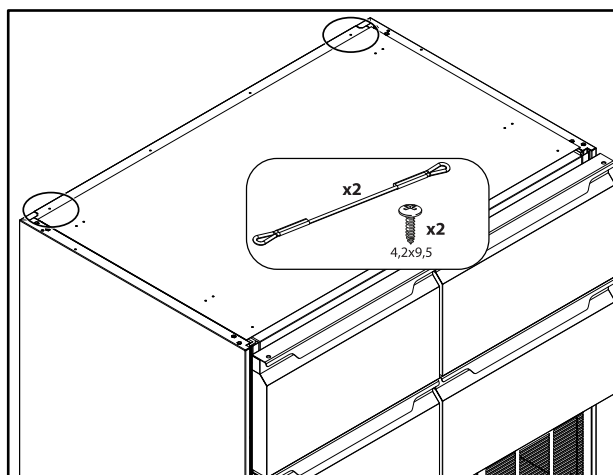

2.

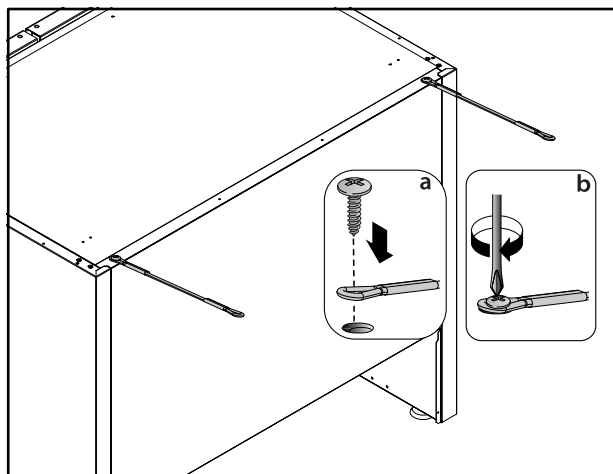

Models with steel top

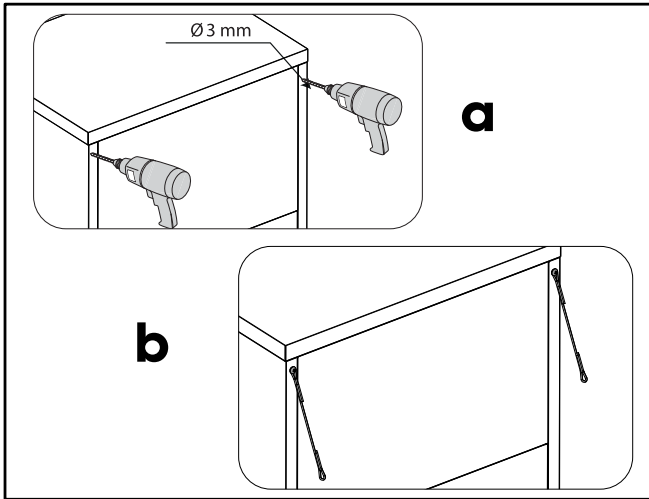

3.

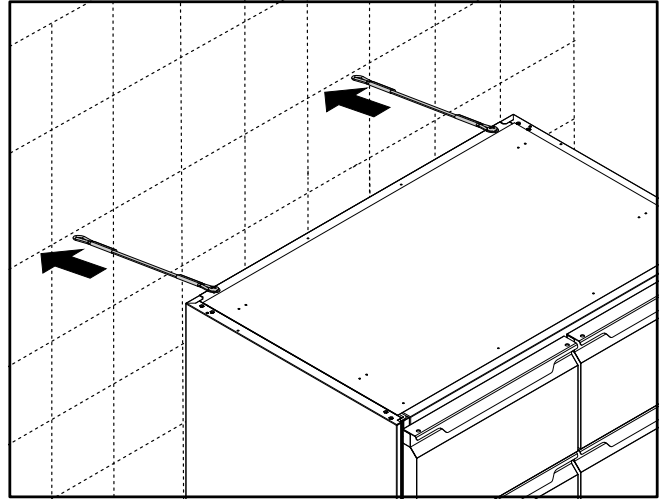

H CONTROL PANEL

H.1 Description of control panel

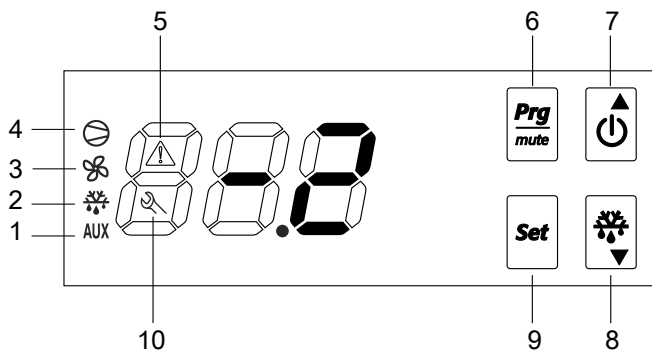

1	Auxiliary users on signalling icon
2	Defrost cycle activated signalling icon
3	Compartment fans on signalling icon
4	Compressor on signalling icon
5	Temperature alarm signalling icon
6	"Prg/mute" button for silencing the alarm buzzer.
7	Multifunction ON/OFF and UP button for switching the appliance on and off and for increasing the values.
8	DOWN and DEFROST button for activating manual defrost and decreasing the values.
9	SET button for accessing the Set point.
10	Service alarm signalling icon



I OPERATION

I.1 Switching on and temperature adjustment

When switched on, the instrument performs a Lamp Test, i.e. for a few seconds the display and icons flash, verifying its correct functioning.

- If the instrument displays the compartment temperature when switched on, the appliance is already on;
- If OFF is displayed, press the ON/OFF button  for a few seconds to activate the appliance; the display shows the message ON and then the compartment temperature.
- To switch the appliance off, press the ON/OFF button for a few seconds; the message OFF appears on the display.

To SET the compartment temperature, proceed as follows:





- Press the button  for a few seconds and the SET POINT value appears on the display.
- To change the SET value, press the increase value button UP  or the decrease value button DOWN .
- If no button is pressed for 60 seconds (TIME OUT), or by pressing the SET button once, the digital thermostat memorises the last set value and the normal display is restored.

The temperature range is set from a minimum to a maximum, according to the following values:

Max. position =	+ 10
Min. position =	0

I.2 Signalling icons

The digital thermostat has the following signalling ICONS:

	lit up	This icon indicates compressor activation.
	lit up	This icon indicates the manual defrost function in progress.
	lit up	This icon indicates activation of compartment fans (if present).
AUX	lit up	This icon indicates activation of auxiliary users (if present).
	lit up	This icon indicates that a service alarm has occurred during appliance operation.
	lit up	Indicates that a temperature alarm has occurred during appliance operation.

I.3 Alarms and signalling

I.3.1 Service alarms and signalling for models 0 °C/+10 °C

The alarm is signalled by lighting up of the icon . Alarm signalling is also indicated by the alarm code appearing on the display.

Example: Alarm signalling due to a faulty probe (compartment probe) appears directly on the instrument display with the message “E0” and “rE” flashing alternately (refer to position 1 of the alarms table).

When the alarm condition ceases, the alarm goes off. Otherwise, contact the After-Sales Service.

I.3.2 Temperature alarms and signalling

The alarm is signalled by lighting up of the icon . Alarm signalling is also indicated by the alarm code appearing on the display.

Temperature alarm signalling, regarding the thermostatting probe, appears directly on the instrument display with the indication “HI” (max. temperature alarm) and “LO” (min. temperature alarm).

I.4 Defrost

• Automatic defrost

The appliance has an automatic defrost function. This function is signalled by lighting up of the “DEFROST” icon .

The defrost water is run into a tray and automatically evaporated.

• Manual defrost activation

Keep the “DOWN” button  pressed for at least 5 seconds to start a manual defrost cycle.

This function is signalled by lighting up of the “DEFROST” icon .

Defrost can be stopped manually by pressing the “DOWN” button  for a few seconds; the display shows the message “dFb”. Defrost cannot be activated in the programming stage.

I.5 Product loading

Distribute the product evenly inside the compartment (away from the door and back) in order to allow good air circulation.



WARNING

Cover or wrap food before placing it in the refrigerator and avoid putting very hot foods or steaming liquids inside.

Do not leave the door open any longer than necessary when loading or removing food.

It is advisable to keep the keys (for models with lock) in a place only accessible to authorised personnel.

To prevent unauthorised personnel from opening the appliance, it is advisable to always close it with the key.

I.6 Tray loading combinations

1/6	1/6	1/6	1/6	1/6	1/6	1/6	1/6	1/6	1/6	1/6	1/6	1/6	1/6	1/6				
1/2		1/2		1/3		1/3		2/3			2/3		1/3		1/1		2/3	

①

②

③

1/6	1/6	1/6	1/6	1/6	1/6	1/6	1/6	1/6	1/6	1/6	1/6	1/6	1/6	1/6						
1/1			1/3		1/3		1/2			1/2		2/3			1/3		1/3		1/3	

④

⑤

⑥

J NORMAL MACHINE USE

J.1 Characteristics of personnel trained for normal machine use

The Customer must make sure the personnel for normal machine use are adequately trained and skilled in their duties, as well as ensuring their own safety and that of other persons.

The Customer must make sure his personnel have understood the instructions received and in particular those regarding work hygiene and safety in use of the machine.

J.2 Characteristics of personnel enabled to operate on the machine

The Customer is responsible for ensuring that persons assigned to the various duties:

- read and understand the manual;
- receive adequate training and instruction for their duties in order to perform them safely;
- receive specific training for correct machine use.

J.3 Operator qualified for normal machine use

Must have at least:

- knowledge of the technology and specific experience in operating the machine;
- adequate general basic education and technical knowledge for reading and understanding the contents of the manual, including correct interpretation of the drawings, signs and pictograms;
- sufficient technical knowledge for safely performing his duties as specified in the manual;
- knowledge of the regulations on work hygiene and safety.

In case of a significant anomaly (e.g. short circuits, wires coming out of the terminal block, motor breakdowns, worn electrical cable sheathing, etc.) the operator for normal machine use must:

- immediately deactivate the machine.

K MACHINE CLEANING AND MAINTENANCE



WARNING

Refer to “Warning and Safety Information”.

K.1 Ordinary maintenance

K.1.1 Care information

The following care operations have to be carried out by the owner and/or user of the appliance.

**IMPORTANT**

Problems resulting from poor or lack of care as hereinafter described will not be covered by the warranty.

**WARNING**

Before carrying out any cleaning or maintenance, disconnect the appliance from the power supply.

K.1.2 Cleaning the cabinet and accessories

Before using the appliance, clean all the internal parts and accessories with lukewarm water and neutral soap, or products that are over 90% biodegradable (in order to reduce the emission of pollutants into the environment), then rinse and dry thoroughly, where possible clean with dishwashing machine. Do not use solvent-based detergents (e.g. trichloro-ethylene) or abrasive powders for cleaning.

Check the power cable regularly and replace it in case of signs of wear. Have the appliance checked periodically (at least once a year).

**CAUTION**

Do not clean the appliance with detergents containing chlorine, solvent-based cleaning products (e.g. trichloro-ethylene), abrasive powders or agents, scouring pads or sponges that could damage the surfaces. Do not use organic solvent substances or essential oils. These substances could damage the parts of the appliance made from synthetic material.

**CAUTION**

Do not use products (even if diluted) containing chlorine (sodium hypochlorite, hydrochloric or muriatic acid, etc.) to clean the floor under the appliance.

**K.1.3 Precautions in case of long idle periods**

If the appliance is not going to be used for some time, take the following precautions:

- disconnect the power supply;
- remove all food from the compartment and clean the inside and accessories;
- clean the cabinet, going over all the stainless steel surfaces vigorously with a rag moistened with paraffin oil to create a protective film;
- leave the door or the drawers open so that air can circulate inside, preventing the formation of unpleasant odours.
- periodically air the premises.

After carrying out maintenance make sure the machine is able to work safely and, in particular, that the protection and safety devices are efficient.

L MACHINE DISPOSAL**L.1 Introduction****WARNING**

Dismantling operations must be carried out by specialised personnel.

**WARNING**

Work on the electrical equipment must only be carried out by specialised personnel, with the power supply disconnected.

L.2 Waste storage

At the end of the product's life-cycle, make sure it is not dispersed in the environment.

Depending on the model, the doors must be removed before scrapping the appliance.

SPECIAL waste materials can be stored temporarily while awaiting treatment for disposal and/or permanent storage. In any case, the current environmental protection laws in the user's country must be observed.

L.3 Procedure regarding appliance dismantling macro operations

Before disposing of the machine, make sure to carefully check its physical condition, and in particular any parts of the structure that can give or break during scrapping.

The machine's parts must be disposed of in a differentiated way, according to their different characteristics (e.g. metals, oils, greases, plastic, rubber, etc.).

Different regulations are in force in the various countries, therefore comply with the provisions of the laws and competent bodies in the country where scrapping takes place. In general, the appliance must be taken to a specialised collection/ scrapping centre.

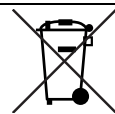

The symbol on the product indicates that this product should not be treated as domestic waste, but must be correctly disposed of in order to prevent any negative consequences for the environment and human health. For further information on the recycling of this product, contact the local dealer or agent, the Customer Care service or the local body responsible for waste disposal.

**WARNING**

Make the appliance unusable by removing the power cable and any compartment closing devices, to prevent the possibility of someone becoming trapped inside.

**NOTE!**

When scrapping the machine, the "CE" marking, this manual and other documents concerning the appliance must be destroyed.

M TROUBLESHOOTING

In some cases, faults can be eliminated easily and quickly by following a brief troubleshooting guide:

ANOMALY	TYPE OF ANOMALY	DESCRIPTION	POSSIBLE CAUSES	ACTIONS
E0 rE	ALARM	Compartment sensor fault	<ul style="list-style-type: none"> • Connector unplugged • Probe and/or Probe wire damaged 	CALL SERVICE
E1	ALARM	Evaporator sensor fault	<ul style="list-style-type: none"> • Connector unplugged • Probe and/or Probe wire damaged 	CALL SERVICE
HI	WARNING	Compartment high temperature alarm	<ul style="list-style-type: none"> • Door or drawers left opened • Excessive load • Malfunctioning on the cooling unit 	If the problem persist Call Service
LO	WARNING	Compartment low temperature alarm	<ul style="list-style-type: none"> • Malfunctioning on the cooling unit 	If the problem persist call service
The appliance does not switch on.	-----	-----	<ul style="list-style-type: none"> • Electric supply issue 	<ul style="list-style-type: none"> • Make sure the plug is properly inserted in power socket. • Make sure the socket is powered. • If the problem persists Call Service.
The inside temperature is too high.	-----	-----	<ul style="list-style-type: none"> • Door or drawers left open • Issue with thermostat setting • Excessive load • Heat source near the appliance 	<ul style="list-style-type: none"> • Make sure the doors or the drawers close properly. • Check the thermostat setting. • Make sure there is no heat source near the appliance. • Make sure the product is correctly loaded. • If the problem persists Call Service.
The appliance is too noisy.	-----	-----	<ul style="list-style-type: none"> • Unit unlevelled or touching other equipment 	<ul style="list-style-type: none"> • Make sure the appliance is properly levelled. An unbalanced position can set off vibrations. • Make sure the appliance is not touching other equipment or parts which could reverberate. • If the problem persists Call Service.

If the fault persists after carrying out the above checks, contact the Customer Care Service, remembering to specify:

- A. the type of fault;
- B. the appliance PNC (production number code);
- C. the Ser. No. (appliance serial number).



NOTE!

The appliance PNC and serial number are essential for identifying the type of appliance and date of manufacture. The dataplate giving the product and technical data is located inside the appliance. The plate giving the appliance PNC code and serial number is located in the unit compartment.

CE